

Rshield

Bio Screen Solutions

A strong safety shield to protect employees and customers by ensuring contact is reduced and social distancing is enforced. The Rshield range is our solution to assist with maintaining a safe work environment, with the intention of preventing the spread of respiratory droplets between people. The BioScreen has two options for material's: clear acrylic for 100% visibility or poly-carbonate for more privacy. They can be incorporated into any work-space or social environment whilst keeping communication clear.

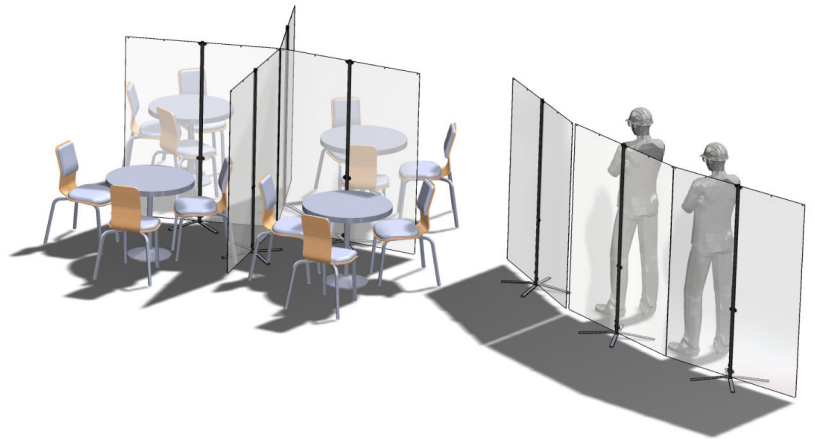
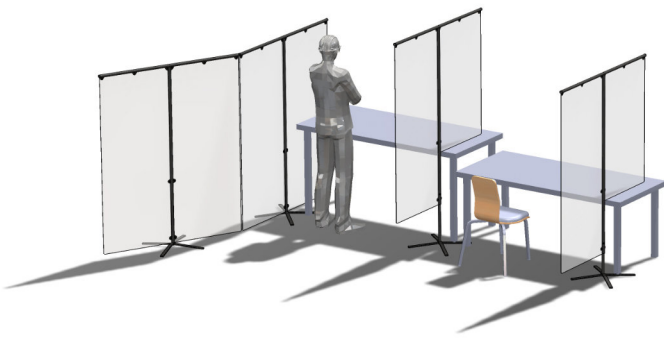

Product Features



Unlike any other design, our protection screens can be linked together at any angle, allowing you to create your own safe spaces and walkways to suit your school or workplace.

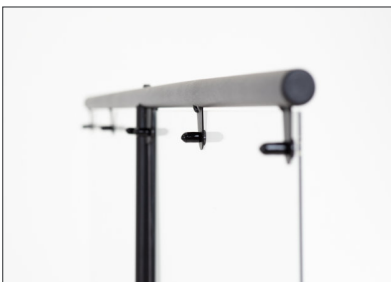

Trouble-free assembly with our easy use T-Frame. Made from top grade steel, you can assemble screens in minutes. The strong, epoxy coated T-frame is durable and aesthetically pleasing.



There is no need for any bolts or screws, our easy fix plugs secure the screen to the frame and give you the ability to remove to clean or reuse the plastic at a later date.



The BioScreen is portable which allows you to move it to any space and change its position at any time. Great for room changes or when they are not required. There is a small stem handle for ease and comfort when moving the shield. The Height Adjustable stem means using just an Allen Key you can adjust the shield (with a range of 500mm) to adapt to any environment, not just for single use!

Product Features



All BioScreens are designed with the X base that allows the Screens to stack together tightly for compact storage and be kept for years to come. The clever shape also ensures it can be safe in a busy environment as there is no trip hazard.

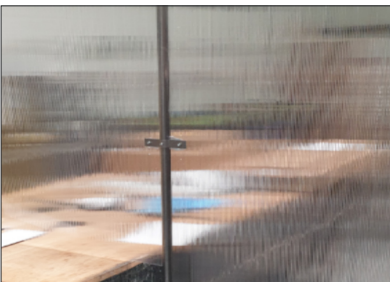

The BioScreen can blend into any environment with our two materials.

The clear acrylic is made from a clear acrylic sheet. Its 100% clear, as if it's not even there!

For more privacy in your works space, a poly carbonate twin wall screen that still allows all of the natural light to be let in.



With facilities in London and Essex all of our Rshield products are designed and made in the UK.



Supporting our health heroes! We want to help give back to all of the front line and key workers who have carried us through this difficult time. 10% of the profit will be donated to the NHS Charities Together. RATstands expects to donate at least £4 per item to the charity. This pandemic has shown us how vulnerable we are to potentially more global crises so let's be prepared and prevent the spread together!

Standard Configurations

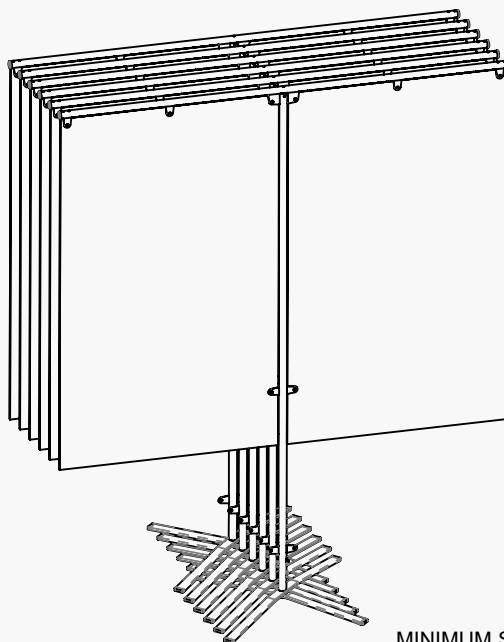
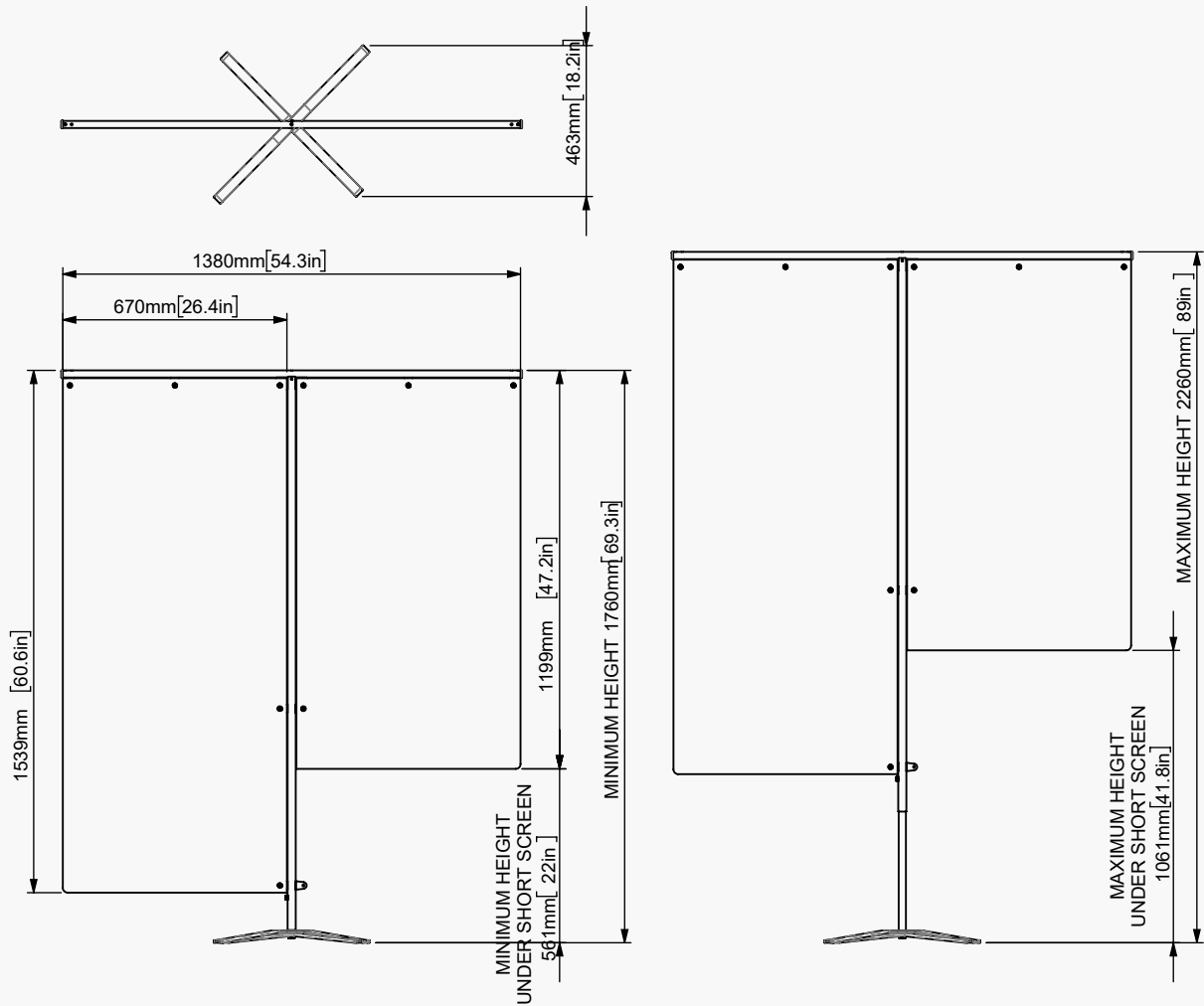

MINIMUM STACKING PITCH 60mm [2 1/4"]

Standard Configurations

OTHER CONFIGURATIONS AND DIMENSIONS CAN BE MADE TO ORDER

USING RIGID TRANSPARENT OR TWIN WALLED SHEET

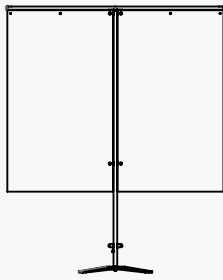

Short Height

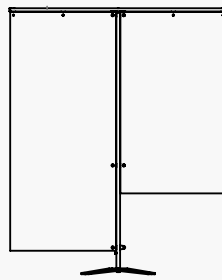

Desk Flag

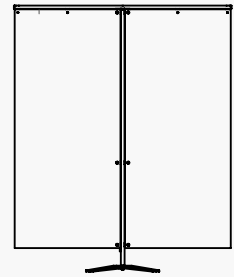

Full Height

Detailed Specification

Specifiers description

The Rshield is our solution to long term bio safety. The BioScreen will act as a physical barrier to aid social distancing and protect people from the spread of bacteria in the air. All 3 versions are designed to offer as much protection as possible whilst you are adjusting back to this new normality. Unlike other designs, each of our screen sizes allow you to relax knowing that you're protected. The BioScreen gives you all the room you need around your work/ social space without feeling closed in.

The Poly-carbonate and Acrylic Plastic materials are easy to clean and wipe down. All of our BioScreens are portable meaning anyone can adjust the layout or move to storage. The height adjustable stem allows you to adapt the screen depending on your situation. A storage trolley is also available (can hold up to 6 screens).

	Desk Flag	Half Height	Full Height
Mild Steel Stem	Y	Y	Y
Mild Steel Base	Y	Y	Y
X Base	Y	Y	Y
T Frame	Y	Y	Y
Height Adjustable	Y	Y	Y
Poly-carbonate	Y	Y	Y
Acrylic Plastic	Y	Y	Y
Front Screen Attachment	Y	Y	Y
Custom sizes available to order	Y	Y	Y
Can be stacked	Y	Y	Y
Weight without packaging	7.6kg	6.9kg	8.3kg
Weight with packaging	TBA	TBA	TBA
Warranty against manufacturing faults	10 Years	10 Years	10 Years

